



# Industrial Wireless

Wireless from the sensor to the network



RSPSupply - 1-888-532-2706 - <https://www.RSPSupply.com>  
See the product details here

# Our Industrial Wireless products for your automation infrastructure

Phoenix Contact is a leading international supplier for automation infrastructure. Industrial Wireless products from Phoenix Contact provide reliability and security for the transmission of data and signals.

Wireless systems enable you to easily and efficiently negotiate the many challenges faced in an industrial communication infrastructure.

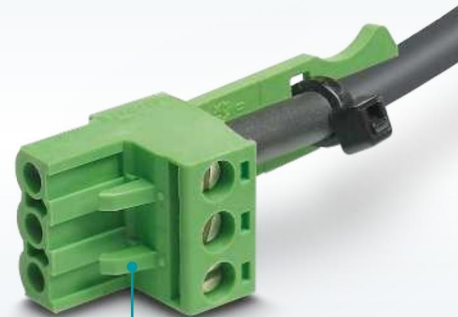

## Your advantages

- ✓ Flexibility, easy installation, and cost savings compared to cable-based installations
- ✓ Bypassing of obstacles
- ✓ Alternative to slip rings that are prone to wear, and to cable lines on mobile devices
- ✓ Reduced maintenance costs
- ✓ Monitoring and control of remote stations without cable access

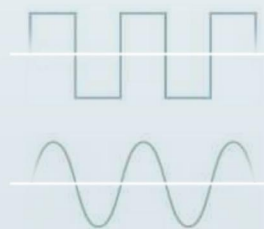

## Wireless I/O

Digital signals:  
0 ... 250 V AC/DC,  
NAMUR

Analog signals:  
0 ... 20 mA, 4 ... 20 mA  
0 ... 10 V, HART

## Wireless systems for all interfaces

Our comprehensive product range offers flexible options for implementing wireless industrial communication solutions. Suitable wireless systems are available for a wide range of interfaces.

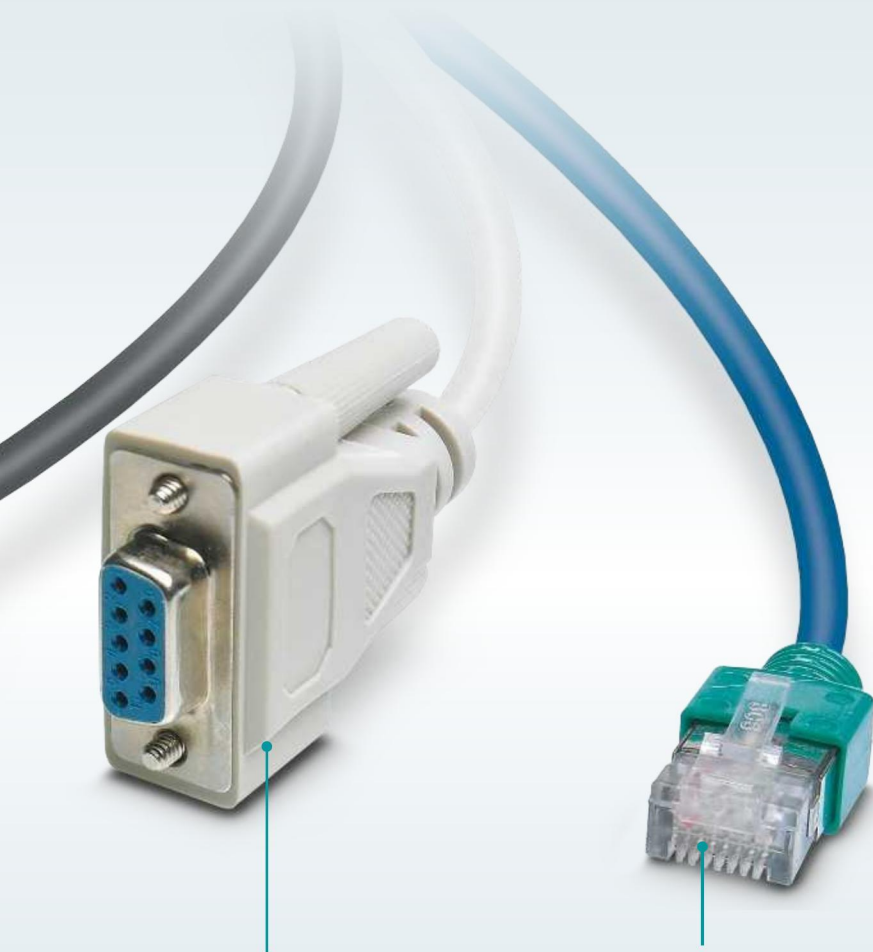

### Wireless Serial



RS-232  
RS-422  
RS-485

### Wireless Ethernet

Ethernet

EtherNet/IP<sup>®</sup>



## Contents

Wireless technologies	4
<hr/>	
Wireless I/O	
Radioline – Distributing signals easily with I/O mapping	6
Radioline – I/O mapping now also available in wired format	8
Radioline expansion modules	10
Radioline – Solutions for use in outdoor applications	12
The Wireless MUX wireless signal cable	14
Extending HART systems and establishing new applications	16
TC Mobile I/O for monitoring sensors via the mobile network	18
<hr/>	
Wireless Serial	
Radioline for wireless networking of serial interfaces	20
<hr/>	
Wireless Ethernet	
Industrial Bluetooth	22
Industrial WLAN	24
Mobile routers for worldwide network access	26
<hr/>	
Accessories	
Antenna installation – Basics and technology	28
Cables and adapters	29
Product overview	30
<hr/>	
Services	34
<hr/>	





# Wireless technologies

The key requirement for the use of wireless technologies in industrial applications is that the technology must be as robust and reliable as a cable connection, even under harsh conditions. With wireless communication, the data is transmitted with electromagnetic waves through free space that is not available exclusively. The wireless connection is therefore subjected to interference, such as electromagnetic interference fields, which can adversely affect transmission. In addition, reflections, fading, interference, and shadowing can occur. Despite the impacts described, the wireless systems work without interference.





# Wireless technologies

Technologies				
				
<b>868/900 MHz, 2.4 GHz</b>	<b>2.4 GHz</b>	<b>2.4 GHz</b>	<b>2.4 GHz, 5 GHz</b>	
Trusted Wireless 2.0 technology is specifically designed for the reliable transmission of data and signals over long distances.	Bluetooth wireless technology is standardized in accordance with IEEE 802.15.1.	WirelessHART wireless technology is standardized in accordance with IEEE 802.15.4. It is used for the wireless networking of HART field devices in the process industry.	WLAN is a wireless standard in accordance with IEEE 802.11 a/b/g/n for creating wireless local area networks.	Communication takes place via the mobile phone networks of the telecommunications provider.
Characteristics				
<ul style="list-style-type: none"> <li>• High degree of reliability, thanks to AES encryption, frequency hopping method, and coexistence management</li> <li>• Range of several kilometers, thanks to adjustable data rates</li> <li>• Mesh networks with up to 250 nodes</li> </ul>	<ul style="list-style-type: none"> <li>• Extremely reliable transmission, thanks to redundant transmission channels</li> <li>• High coexistence capability in unfamiliar wireless environments, parallel operation of several Bluetooth systems at one location thanks to efficient frequency usage</li> <li>• Ranges of up to 200 m</li> <li>• Short delay times</li> </ul>	<ul style="list-style-type: none"> <li>• Extremely secure transmission protected against manipulation with 128 bit AES encryption</li> <li>• High degree of reliability, thanks to full-mesh routing</li> <li>• Very low energy consumption, thanks to time-synchronized communication</li> </ul>	<ul style="list-style-type: none"> <li>• High data rates of up to 54 Mbps or 300 Mbps</li> <li>• Fast roaming</li> <li>• Device mobility in wide area networks</li> <li>• High degree of reliability, thanks to MIMO technology</li> </ul>	<ul style="list-style-type: none"> <li>• Available worldwide</li> <li>• Use of international mobile network standards (GPRS, EDGE, UMTS, HSPA, LTE, etc.)</li> <li>• Data rates of up to 150 Mbps on the LTE network</li> <li>• Inexpensive alarm generation via SMS</li> </ul>
Applications				
<ul style="list-style-type: none"> <li>• <b>Wireless I/O:</b> Analog, digital I/O signals (support modular expansion)</li> <li>• <b>Wireless Serial:</b> Serial RS-232, RS-485 data</li> </ul>	<ul style="list-style-type: none"> <li>• <b>Wireless I/O:</b> Analog, digital I/O signals</li> <li>• <b>Wireless Ethernet:</b> Ethernet data</li> </ul>	<ul style="list-style-type: none"> <li>• <b>Wireless I/O:</b> Analog HART signals</li> </ul>	<ul style="list-style-type: none"> <li>• <b>Wireless Ethernet:</b> High-speed Ethernet transmission</li> </ul>	<ul style="list-style-type: none"> <li>• <b>Wireless I/O:</b> Analog, digital I/O signals</li> <li>• <b>Wireless Serial:</b> Serial RS-232 data</li> <li>• <b>Wireless Ethernet:</b> Ethernet data</li> <li>• <b>Alarm generation:</b> SMS, e-mail</li> </ul>

## Industrial Wireless in process technology and production automation

Process technology systems often feature widely distributed outdoor system structures. Measured values only ever change very gradually.

In contrast to process technology systems, systems used in production automation are often physically restricted in terms of space. Large amounts of data have to be transferred in a very short amount of time.

We offer the suitable wireless system for every application.



System expansion and post installation



Dynamic applications

Wireless I/O

# Radioline – Easy signal distribution with I/O mapping

Radioline is the wireless system for large systems and networks.

Special features include extremely easy assignment of inputs and outputs by simply turning the thumbwheel – without any programming. Radioline transmits I/O signals as well as serial data and is therefore very versatile. In addition, you can implement various network structures: from a simple point-to-point connection to complex networks.



TRUSTED  
WIRELESS™



## Your advantages

- ✓ Easy startup without programming
- ✓ One device for a range of applications
- ✓ Integrated RS-232 and RS-485 interface
- ✓ Trusted Wireless 2.0 technology
- ✓ Adjustable data rates for the wireless interface
- ✓ 128-bit data encryption (AES)

# Product overview Radioline front modules



## 868 MHz wireless module

RAD-868-IFS (Europe) Order No. [2904909](#)

- Supply voltage: 19.2 ... 30.5 V DC
- Adjustable transmission power of up to 500 mW
- Can be extended with I/O modules via DIN rail connectors
- Expanded temperature range: -40°C ... +70°C
- Antenna connection: RSMA (female)
- Approvals: ATEX, IECEx
- Suitable for large distances with obstacles

## 900 MHz wireless module

RAD-900-IFS (America) Order No. [2901540](#)  
 RAD-900-IFS-AU (Australia, New Zealand) Order No. [2702878](#)

- Supply voltage: 10.8 ... 30.5 V DC
- Adjustable transmission power of up to 1000 mW
- Can be extended with I/O modules via DIN rail connectors
- Expanded temperature range: -40°C ... +70°C
- Antenna connection: RSMA (female)
- Approvals: UL 508, HazLoc, FCC
- Suitable for large distances with obstacles

## 2.4 GHz wireless module

RAD-2400-IFS (worldwide) Order No. [2901541](#)  
 RAD-2400-IFS-JP (Japan) Order No. [2702863](#)

- Supply voltage: 19.2 ... 30.5 V DC
- Adjustable transmission power of up to 100 mW
- Can be extended with I/O modules via DIN rail connectors
- Expanded temp. range: -40°C ... +70°C
- Antenna connection: RSMA (female)
- Approvals: ATEX, IECEx, UL 508, HazLoc, FCC (RAD-2400-IFS only)

Radioline accessories are to be found on page 33.

## One device – A wide range of applications

Radioline is very versatile thanks to the fact that it can transmit I/O signals as well as serial data – the Trusted Wireless technology ensures reliable transmission even in harsh industrial environments, regardless of the protocol type. The Radioline function blocks for PC Worx, STEP 7 and TIA Portal enable easy I/O integration in the control level.

### PC Worx/STEP 7 function blocks

- Free Radioline library
- Central monitoring of wireless stations in the control system

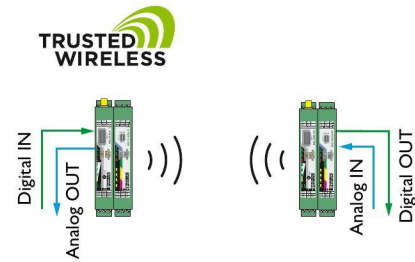

I/O data mode

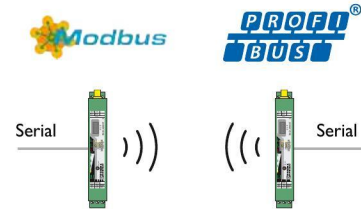

Serial data mode

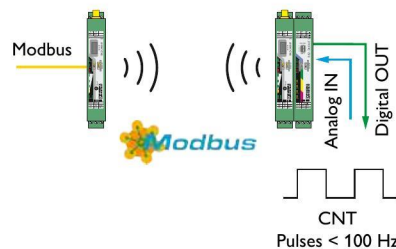

PLC/Modbus RTU mode

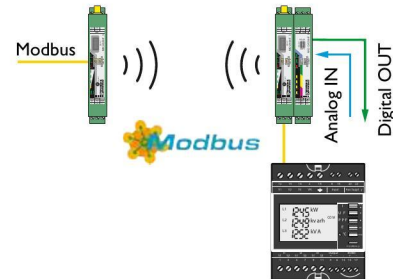

PLC/Modbus RTU dual mode



Wireless I/O

## Radioline – I/O mapping now in wired format too

The popular, straightforward method of distributing I/O information using thumbwheels on the front of the equipment is now also available for RS-485 networks. Addressing the new RS-485 front module is quick and easy too – all it takes is a turn of the yellow thumbwheel. This enhances the Radioline system's flexibility, allowing you to use it for solutions in even more applications.

### Alternative transmission media

To increase the range, you can of course replace the RS-485 line with alternative transmission media. Phoenix Contact offers a range of converters for fiber-optic cables, SHDSL, wireless, or Ethernet technology.

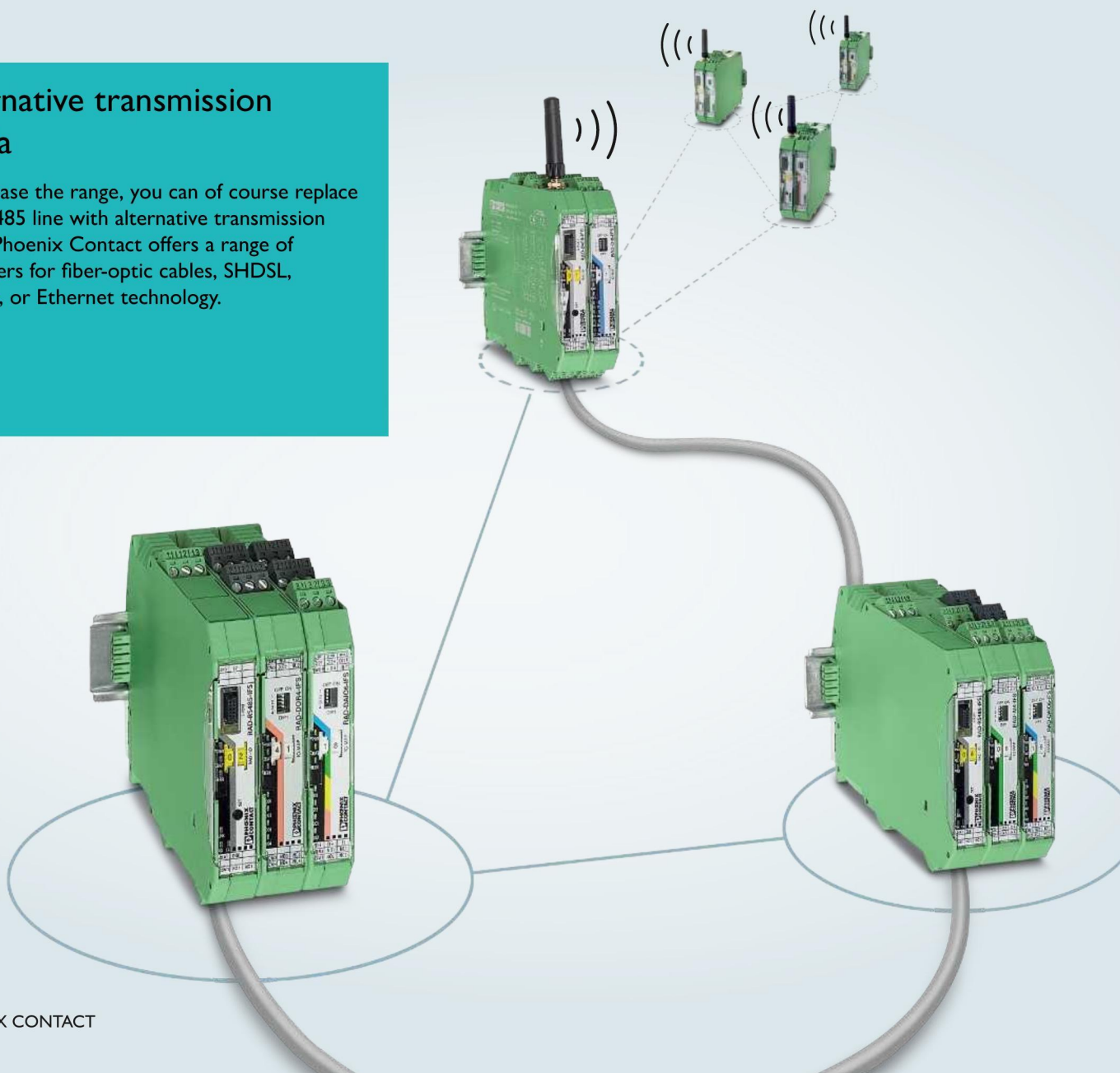



# Product overview Radioline bus module



## RS-485 bus module

RAD-RS485-IFS

Order No. 2702184

- Expanded temperature range: -40°C ... +70°C
- RS-485 2-wire connection (screw terminal block)
- Worldwide use
- Range: 1200 m or more with converter or repeater
- Can be extended with I/O modules via DIN rail connectors
- Supply voltage: 19.2 ... 30.5 V DC

## Signal transmission with the Radioline RS-485 bus module

A network may consist either entirely of wireless stations or entirely of RS-485 stations. Alternatively, it is also possible to combine a wireless network with RS-485 stations.

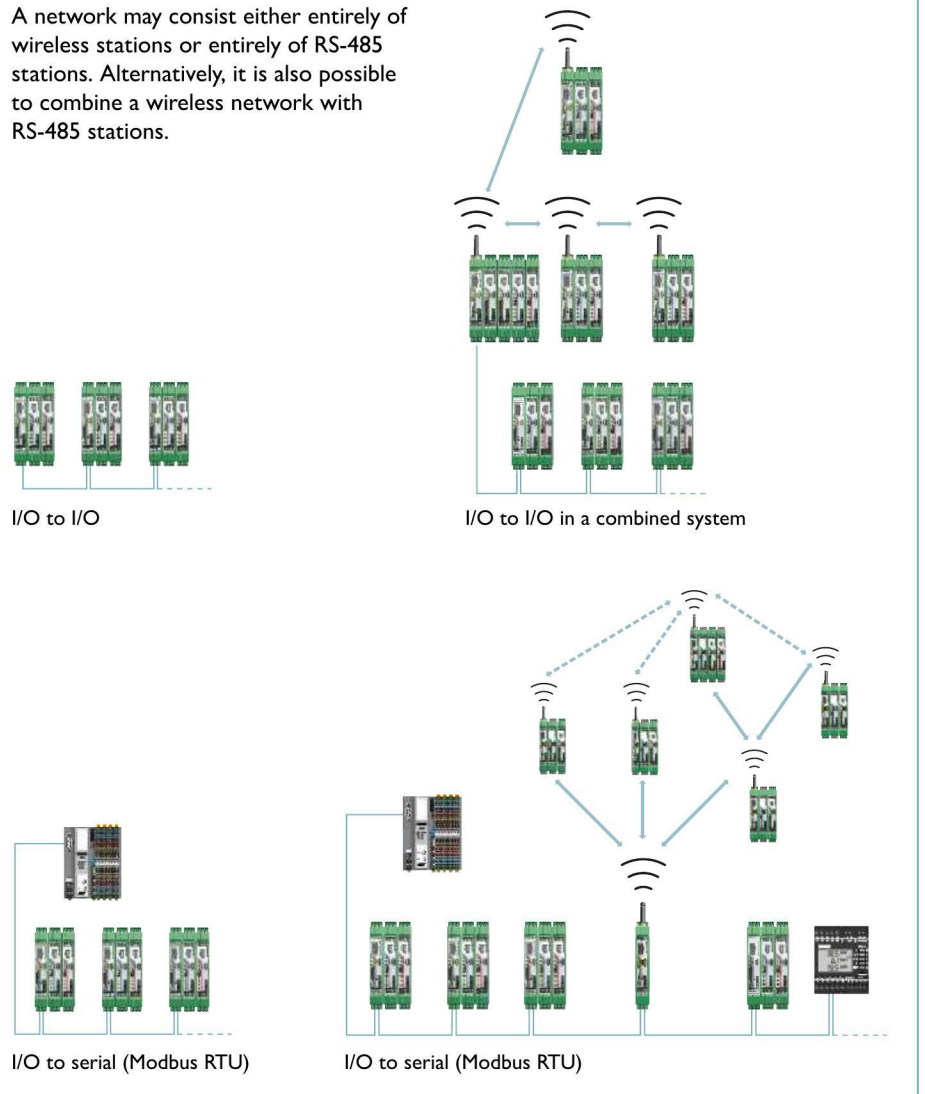

### Connection to the wireless system

A Radioline wireless system on an existing master can be expanded to include new RS-485 stations. The wireless and RS-485 modules form a combined system.



### Multipoint multiplexer

In an RS-485 network with up to 99 Radioline stations, you can now distribute I/O signals between stations entirely without the need for software configuration – all it takes is a turn of the thumbwheel.



### Stand-alone operation as a Modbus slave

The new Radioline RS-485 stations can also be operated on any Modbus RTU master.

## Wireless I/O

# Radioline expansion modules

Various expansion modules are available for expanding the Radioline wireless system quickly and easily. They enable the transmission of digital and analog signals as well as temperature signals.

All expansion modules are certified in accordance with 94/9/EC (ATEX) directives and can therefore be used internationally in potentially explosive areas.

### Your advantages

- ✓ I/O expansion modules can be used on all front modules (see page 7)
- ✓ Modular expansion possible
- ✓ Easy module replacement even during operation (hot swap-capable)
- ✓ Channel-to-channel electrical isolation
- ✓ Expanded temperature range: -40°C ... +70°C

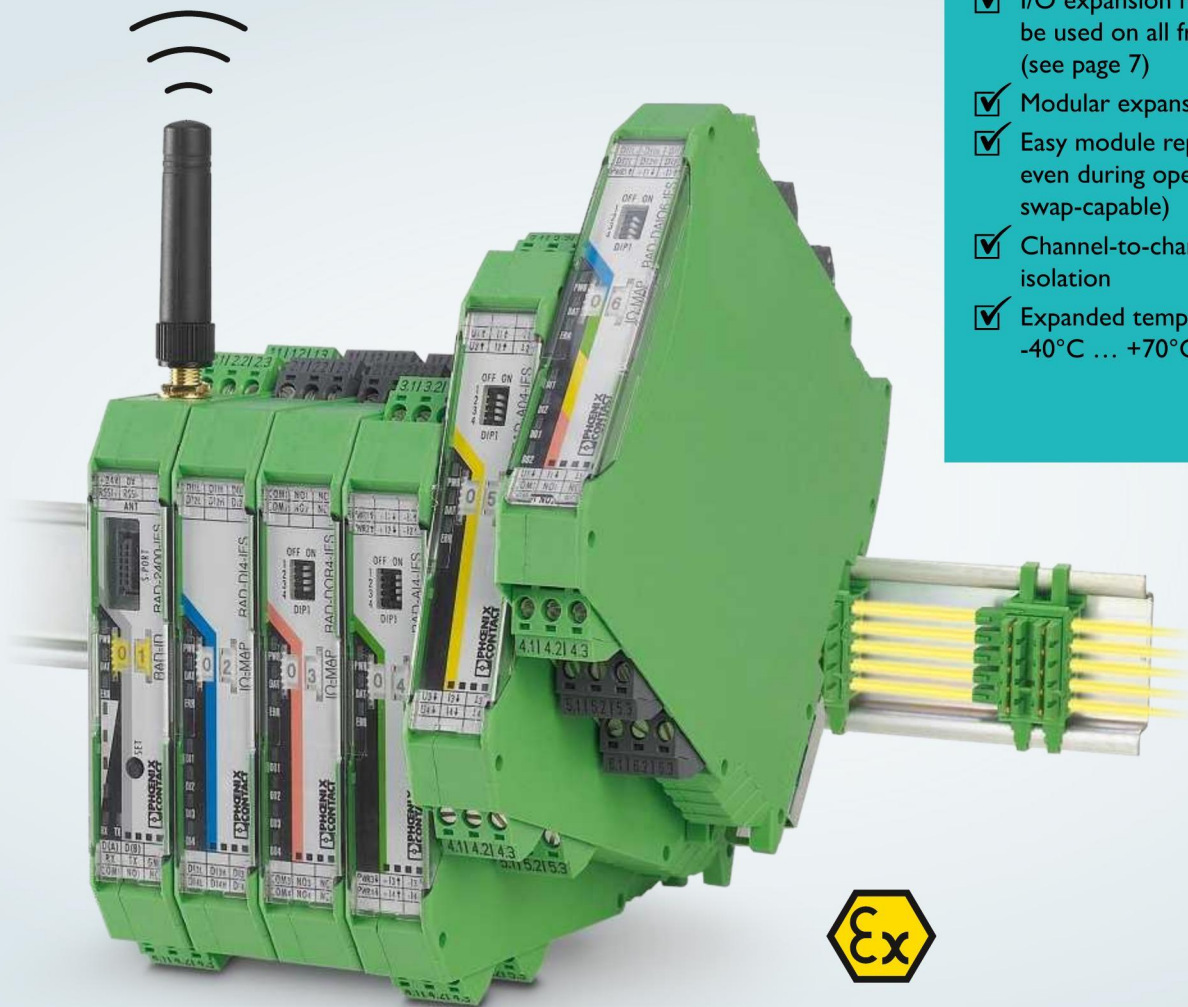

# Product overview Radioline expansion modules



## Digital expansion modules

RAD-DI4-IFS Order No. [2901535](#)  
 RAD-DOR4-IFS Order No. [2901536](#)

- 4 digital wide-range inputs: 0 ... 250 V AC/DC
- 4 digital relay outputs: 24 V DC/250 V AC/5 A

RAD-DI8-IFS Order No. [2901539](#)  
 RAD-DO8-IFS Order No. [2902811](#)

- 8 digital inputs: 0 ... 30.5 V DC
- 2 pulse inputs: 100 Hz, 32 bit
- 8 digital transistor outputs: 30.5 V DC/200 mA

RAD-NAM4-IFS Order No. [2316275](#)

- 4 digital NAMUR inputs
- Line break detection
- Short-circuit detection
- Can be combined with RAD-DO8-IFS

## Analog/Pt 100 expansion module

RAD-AI4-IFS Order No. [2901537](#)

- 4 analog inputs: alternatively 0/4 ... 20 mA

RAD-AI4-U-IFS Order No. [2702290](#)

- 4 analog inputs: 0 ... 5/10 V

RAD-AO4-IFS Order No. [2901538](#)

- 4 analog outputs: alternatively 0/4 ... 20 mA, 0 ... 10 V DC

RAD-PT100-4-IFS Order No. [2904035](#)

- 4 Pt 100 inputs
- Temperature measuring range: -50°C ... +250°C
- 2-/3-conductor connection
- Can be combined with RAD-AO4-IFS

## Analog/digital expansion module

RAD-DAIO6-IFS Order No. [2901533](#)

- 1 analog input: alternatively 0/4 ... 20 mA
- 1 analog output: alternatively 0/4 ... 20 mA, 0 ... 10 V DC
- 2 digital wide-range inputs/outputs: 0 ... 250 V AC/DC



## Easy installation

Create a modular wireless station in the control cabinet and extend or replace it easily during operation.



## Unique addresses for front modules

Set a unique address on the front module by simply turning the thumbwheel.

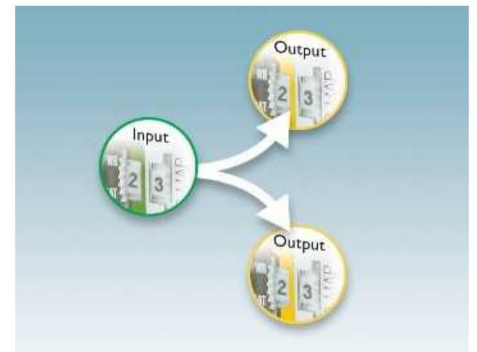

## Distribute inputs and outputs

On the I/O module, the thumbwheel is used to assign the inputs and outputs by creating pairs, thereby easily distributing the I/O signals in the system (I/O mapping).



Wireless I/O

## Radioline – Solutions for use in outdoor applications

The Radioline Outdoor boxes can be installed outdoors in order to remotely transfer I/O signals or serial data quickly and easily. The device combinations are freely selectable. This enhances the Radioline system's flexibility, allowing you to use it for solutions in even more applications.



### Your advantages

- ✓ Robust, impact-resistant, UV-resistant, and splash-proof outdoor housing (IP66/NEMA 4X)
- ✓ Prewired box enables immediate installation
- ✓ Intuitive startup and configuration
- ✓ Flexible in physical terms, thanks to ranges covering several kilometers





# Product overview Radioline Outdoor boxes



## For worldwide use

RAD-RUGGED-BOX-CONF

Order No. [1091638](#)

- Wireless module (selectable): 868 MHz, 900 MHz or 2,400 MHz
- Can be extended with up to three selectable I/O expansion modules
- Serial RS-232/RS-485 interface
- Including surge protection, antenna feed-through, and a pressure compensation element
- Ambient temperature: -25°C ... 55°C
- Universal power supply unit: 100 ... 240 V AC
- Degree of protection: IP66
- Antenna connection: N (female)
- Approvals: CE

## For use in America

RAD-900-DAIO6

Order No. [2702877](#)

- Integrated 900 MHz wireless module
- 6 integrated I/O channels (2 x DI/DO, 1 x AI/AO)
- Connection to RAD-900-IFS wireless modules possible
- Ambient temperature: -40°C ... 65°C
- Universal power supply unit: 100 ... 240 V AC/10.8 ... 30.5 V DC
- Degree of protection: NEMA 4X (IP66)
- Antenna connection: N (female)
- Approvals: ANSI/ISA/CSA 22.2 61010-2-201, UL 50E Type 4, Class I, Div. 2, Groups A, B, C, D T4, Class I, Zone 2, IIC T4

Radioline accessories are to be found on page 33.

## Application examples for Radioline Outdoor boxes

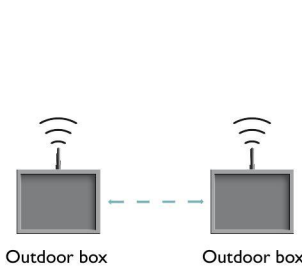

Point-to-point connection with two Outdoor boxes

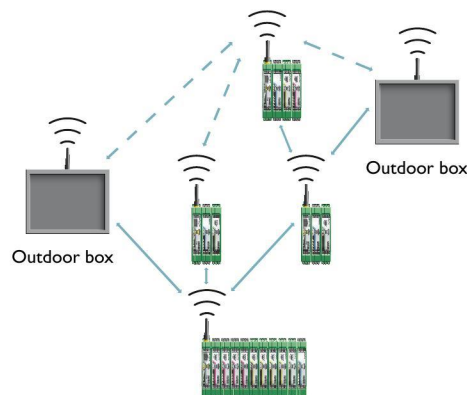

Point-to-point/star/mesh connection with standard wireless modules and Outdoor boxes

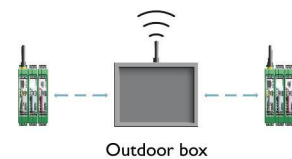

Mesh network with one Outdoor box as a simple repeater

## Wireless I/O

# The Wireless MUX wireless signal cable

The wireless multiplexer transmits 16 digital and two analog signals bidirectionally, i.e. in both directions, which means that it can replace a 40-wire signal cable. Also, the connection is monitored continuously. If there is gross interference in the link or it is interrupted, the outputs are reset to the defined LOW state. This is indicated on the module by a diagnostic LED. The link quality display provides the user with constant information on the quality of the link.

### Your advantages

- ✓ Connections established and signals transmitted automatically based on fixed pairing
- ✓ No configuration or settings required
- ✓ Typical transmission time of less than 10 ms
- ✓ Extremely robust and reliable
- ✓ Interference-free operation alongside WLAN



## Product overview wireless sets



### Mobile set with antennas

ILB BT ADIO MUX-OMNI

Order No. [2884208](#)

- Standard package consisting of two permanently paired modules, two omnidirectional antennas with 1.5 m cable
- Ranges between 50 and 100 m in halls and over 200 m outdoors
- Antenna connection: RSMA (female)
- Approvals: FCC, UL 508, MIC (Japan)

### Wireless set without antennas

ILB BT ADIO MUX

Order No. [2702875](#)

- Package consisting of two permanently paired modules
- Ranges of over 400 m with directional antennas with a free line of sight
- Antenna connection: RSMA (female)
- Approvals: FCC, UL 508, MIC (Japan)

### Technical data for wireless sets:

- Current Bluetooth 4.0 technology
- Supply voltage: 19.2 V DC ... 30 V DC
- 16 digital inputs
- 16 digital outputs up to 500 mA
- 2 analog inputs/outputs 0 ... 20 mA or 0 ... 10 V

## Wireless MUX, the wireless signal cable

Connection to the controller is quick and easy using existing input and output channels.

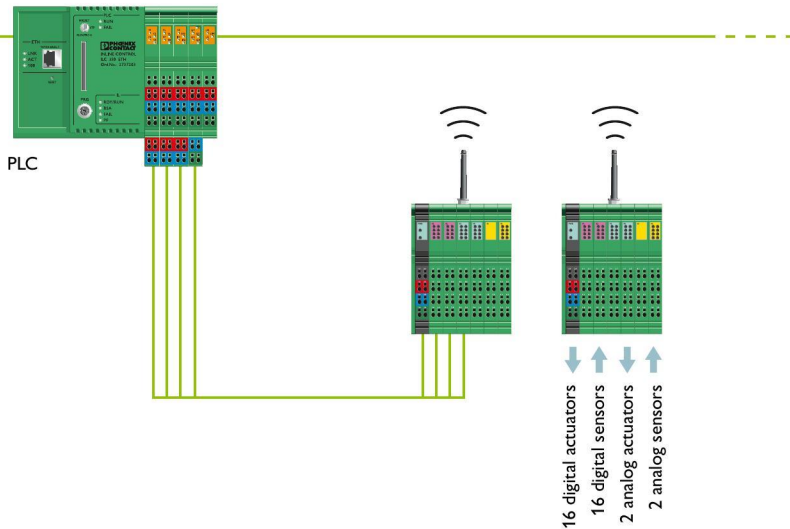

Ready to use: unpack, connect, and switch on

## Possible areas of application

The Wireless MUX is used wherever a small number of digital or analog input and output signals need to be exchanged wirelessly with a remote or movable station.

Factory automation in particular is characterized by machine parts that are constantly in motion.



Dynamic applications



## Wireless I/O

# Expanding HART systems and establishing new applications

By using a WirelessHART adapter and the gateway, it is possible to adapt existing systems to new regulations, optimize maintenance schedules or acquire standard data. The gateway can communicate with the control system via Modbus/TCP, HART-IP, and FDT/DTM. Thanks to the use of HART-IP or FDT/DTM framework structures, remote devices can be fully configured via the wireless network.

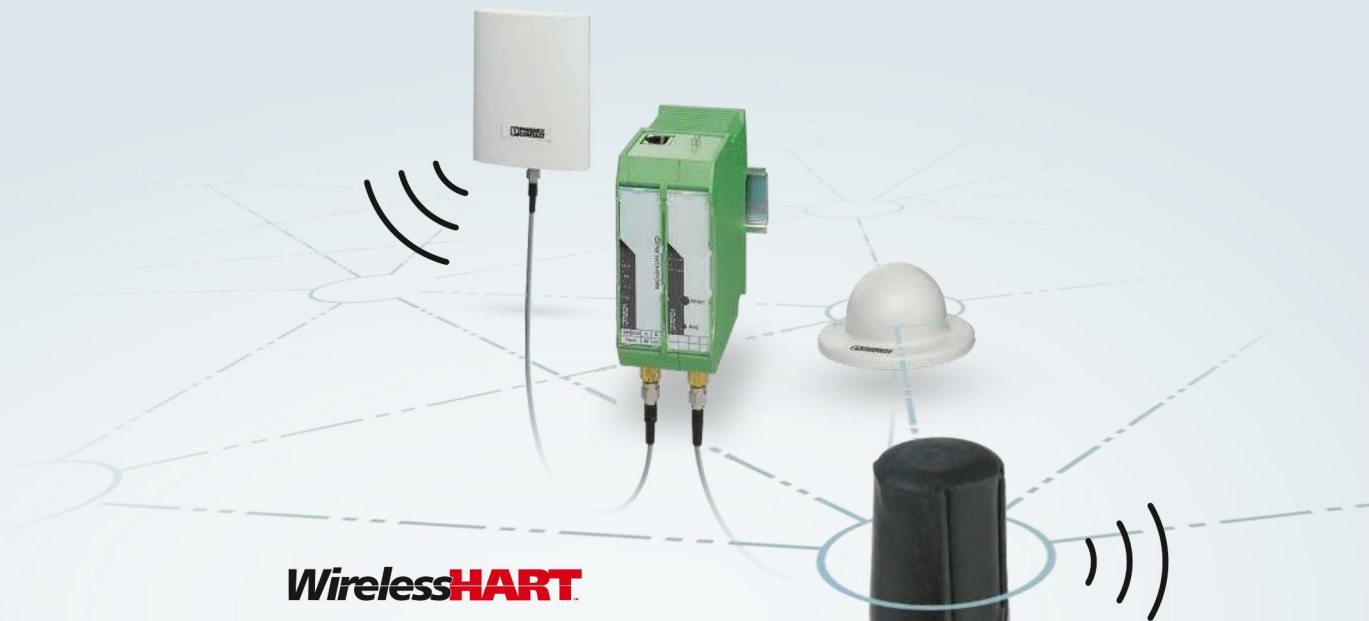

### Your advantages

- ✓ Use of the same maintenance and diagnostic tools as wired HART devices
- ✓ Integrated WLAN client enables the gateways to be installed directly in the field, thereby establishing a reliable network
- ✓ Lower material and installation costs compared to wired solutions
- ✓ Labor costs saved





# Product overview HART systems



## WirelessHART gateway

RAD-WHG/WLAN-XD

Order No. [2900178](#)

- Enables HART data from field devices to be accessed via Modbus/TCP or HART-IP
- Supports up to 250 WirelessHART field devices
- Easy programming and diagnostics by means of integrated web server



## WirelessHART adapter:

RAD-WHA-1/2NPT

Order No. [2900100](#)

- Up to four HART devices or one 4 ... 20 mA non-HART device can be connected to one adapter
- Power supply: loop-powered or 24 V DC
- Removable antenna for connecting a coaxial cable and a high-gain antenna



## Cable adapter

GW HART USB MODEM

Order No. [1003824](#)

- Cost-effective alternative to hand-held programming devices
- Power supply via USB
- Fast configuration of HART devices and rapid diagnostics

## The solution for retrofit and new installations

### Retrofit installation

WirelessHART can:

- Meet new directives
- Increase efficiency
- Lower maintenance costs

### New installation

WirelessHART can:

- Accelerate system extension
- Reduce start time
- Lower investment costs

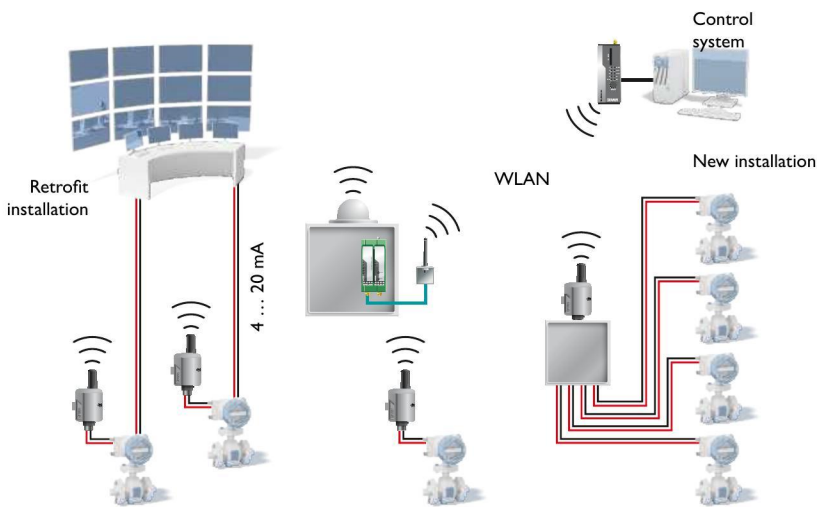

## Possible areas of application

Conventional analog field devices in the process industry which are connected to non-HART-compatible control systems can be expanded easily in terms of their function without needing to replace the existing controller hardware by using WirelessHART networks. A wide range of parameterization and diagnostic functions are integrated into the existing system without having to stop the process.



Applications in the process industry

## Wireless I/O

# TC Mobile I/O for monitoring sensors via the mobile phone network

Monitor analog and digital values easily and securely via the mobile phone network and switch relays remotely. TC MOBILE I/O sends your data as a text message and e-mail whenever an event arises, or continuously via ODP protocol. Thanks to the broad voltage range and the various inputs, the signaling system can be used in a wide range of applications.



**lte**

**GSMA**

### Your advantages

- ✓ Future-proof, thanks to 4G mobile network technology (LTE)
- ✓ Suitable for buildings and harsh industrial environments
- ✓ Monitoring of connected sensors (0/4 ... 20 mA)
- ✓ Monitoring of voltages up to 60 V
- ✓ Relay switching via the mobile phone network
- ✓ SMS alert in the event of power failure

# Product overview TC Mobile I/O



## Mobile radio module, DC

TC MOBILE I/O X200-4G

Order No. **1038567**

4G remote signaling system, SMS/e-mail

TC MOBILE I/O X200 Order No. **2903805**

Remote signaling system, SMS/e-mail

TC MOBILE I/O X300 AC

Order No. **2903807**

Remote control system, GPRS  
(ODP protocol)

- 4 digital inputs
- 4 relay outputs
- 2 analog inputs for current or voltage
- Voltage range: 10 V DC ... 60 V DC



## Mobile radio module, AC

TC MOBILE I/O X200-4G AC

Order No. **1038568**

4G remote signaling system, SMS/e-mail

TC MOBILE I/O X200 AC

Order No. **2903806**

Remote signaling system, SMS/e-mail

TC MOBILE I/O X300 AC

Order No. **2903808**

Remote control system, GPRS  
(ODP protocol)

- 4 digital inputs
- 4 relay outputs
- Voltage range: 93 V AC ... 250 V DC

## TC Mobile I/O app

This app allows you to switch your outputs conveniently and easily check the status of your device at any time. The TC Mobile I/O app makes it even easier to handle the text message version and saves you from having to write a text message. You will receive the alarm as usual via SMS and e-mail. This ensures the best accessibility in the field.



iOS



Android

## Monitoring sensors via the mobile phone network

The TC Mobile I/O product range allows you to monitor analog current levels and analog voltage values and switch relays remotely. Communication takes place via SMS, e-mail or with an ODP server.

Possible areas of application:

- Machine, building, and system monitoring
- Pumps, wastewater treatment plants, and water supply
- Lighting control systems and remote switching devices
- Street lighting
- Elevators and gates
- Alarm technology and building services
- HVAC technology
- Battery monitoring up to 60 V
- Railway applications in accordance with EN 50121-4

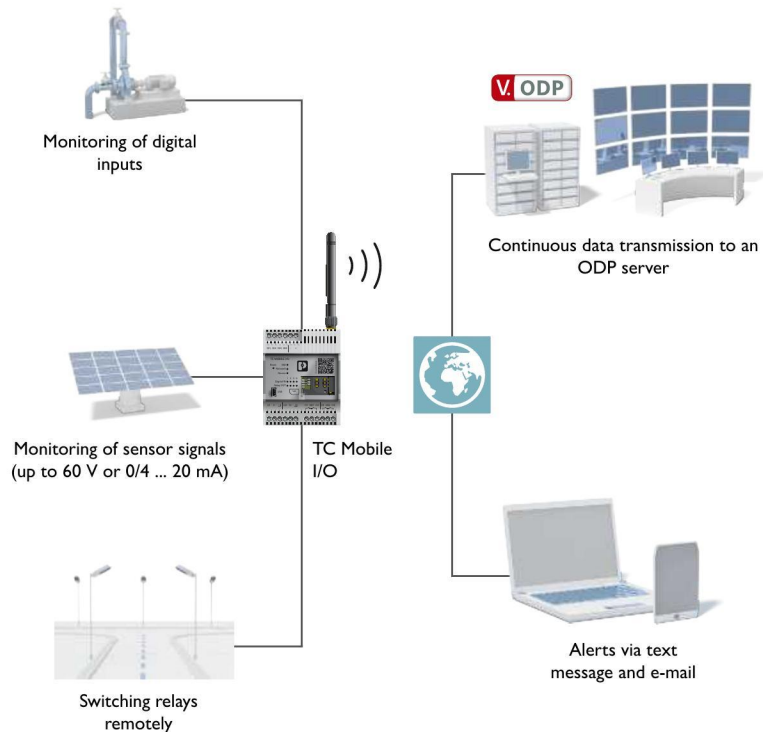



## Wireless Serial

# Radioline for wireless networking of serial interfaces

The wireless module can be used to wirelessly network multiple controllers or serial I/O devices quickly and easily via RS-232 and RS-485 serial interfaces. Data transmission is transparent, which means that any protocols, such as Modbus, can be forwarded. Furthermore, various network structures can be realized: from a simple point-to-point connection through to complex mesh networks.



TRUSTED  
WIRELESS™



### Your advantages

- ✓ Quick and easy startup
- ✓ Easy point-to-point or network connections (star, mesh)
- ✓ Can be extended with up to 32 I/O modules per station via DIN rail connectors (hot-swap capability)
- ✓ I/O-to-I/O, I/O-to-serial, serial-to-serial
- ✓ Trusted Wireless 2.0 technology
- ✓ Adjustable data rates for the wireless interface (16 ... 500 kbps)
- ✓ 128-bit data encryption (AES)



RS-232

RS-485





# Product overview Radioline



## Wireless module

- RAD-868-IFS (Europe) Order No. [2904909](#)
- RAD-900-IFS (Canada, North/South America) Order No. [2901540](#)
- RAD-2400-IFS (worldwide) Order No. [2901541](#)
- RAD-2400-IFS-JP (Japan) Order No. [2702863](#)

- Integrated RS-232 and RS-485 interface
- Can be extended with I/O modules via DIN rail connectors
- Extended temperature range: -40°C ... +70°C

## I/O expansion modules

- Digital IN:
  - RAD-DI4-IFS Order No. [2901535](#)
  - RAD-DI8-IFS Order No. [2901539](#)
  - RAD-NAM4-IFS Order No. [2316275](#)
- Digital OUT:
  - RAD-DOR4-IFS Order No. [2901536](#)
  - RAD-DO8-IFS Order No. [2902811](#)
- Analog/digital IN/OUT:
  - RAD-DAIO6-IFS Order No. [2901533](#)

- Analog IN:
  - RAD-AI4-IFS Order No. [2901537](#)
  - RAD-AI4-U-IFS Order No. [2702290](#)

- Analog OUT:
  - RAD-AO4-IFS Order No. [2901538](#)

- Temperature IN:
  - RAD-PT100-4-IFS Order No. [2904035](#)

Radioline accessories are to be found on page 33.

## Replacement for serial cabling

Connect your controller to serial field devices using wireless technology. The slaves are connected directly or via repeater slave intermediate stations. This means that you can connect up to 250 repeater slaves in series in order

to extend the wireless path. Serial I/O devices and I/O expansion modules can be connected to the intermediate stations.

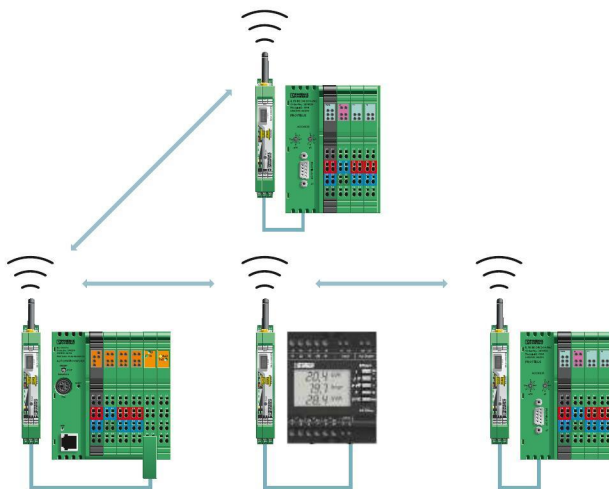

Wireless networking of serial devices

## Convenient software diagnostics

All network devices can be monitored easily via the master:

- Online diagnostics:
  - Network structure design, signal quality of each network station (RSSI), recording of RSSI signal and I/O status of each networked station
- Exclusion of up to two frequency bands (WLAN channels)
- Extended network settings

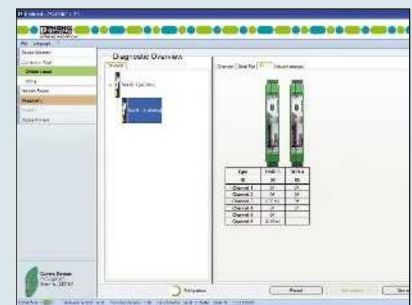

Comprehensive diagnostics

## Wireless Ethernet

# Industrial Bluetooth

The industrial Bluetooth modules allow you to wirelessly transmit control data to mobile or difficult to access automation devices quickly and easily. Bluetooth communication is characterized by particularly robust transmission under difficult ambient conditions.

The FL EPA 2 wireless modules enable you to transmit industrial protocols such as PROFINET without any problems. You can also realize functionally safe communication, via PROFIsafe or SafetyBridge Technology.

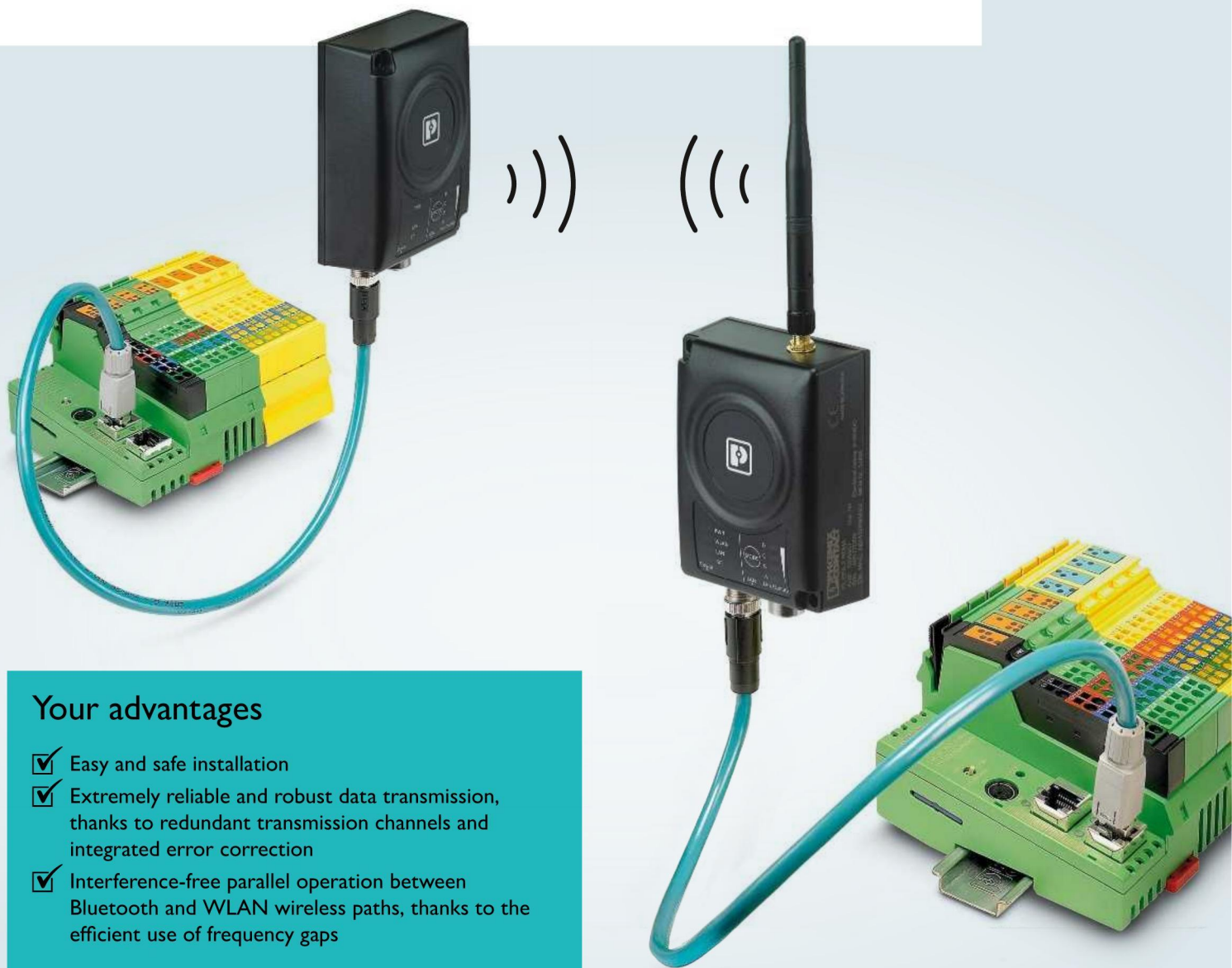

### Your advantages

- ✓ Easy and safe installation
- ✓ Extremely reliable and robust data transmission, thanks to redundant transmission channels and integrated error correction
- ✓ Interference-free parallel operation between Bluetooth and WLAN wireless paths, thanks to the efficient use of frequency gaps

SafetyBridge Technology<sup>®</sup>  
Designed by PHOENIX CONTACT

# Product overview Industrial Bluetooth



## Bluetooth Ethernet adapter

FL BT EPA 2

Order No. [1005869](#)

- Internal antenna
- Bluetooth (PAN profile)



## Wireless Ethernet adapter

FL EPA 2

Order No. [1005955](#)

- Internal antenna
- Bluetooth (PAN profile)
- WLAN 80211 a/b/g/n (access point und client)



## Wireless Ethernet adapter

FL EPA 2 RSMA

Order No. [1005957](#)

- External, replaceable antenna (supplied, connection: RSMA (male))
- Bluetooth (PAN profile)
- WLAN 80211 a/b/g/n (access point und client)

### Technical data:

- Frequency band: 2.4 GHz/5 GHz
- 128-bit data encryption, WLAN black channel list, low emission mode (LEM)
- Degree of protection IP65
- M12 connections for power and LAN

- Auto crossing, PROFINET prioritization, LLDP
- Power supply: 9 ... 30 V DC
- Temperature range: -40°C ... +65°C
- UL/cUL Class 1 Div 2 Hazardous location

- Configuration via MODE button, web interface, SNMP and AT commands
- Accessories: Assembly adapter ([2701134](#)), DIN rail adapter ([2701133](#))

## Bluetooth applications

The Bluetooth BT EPA 2 modules replace individual Ethernet or PROFINET cables leading to automation devices with a reliable wireless connection.

They enable up to seven Bluetooth modules to be connected to the Ethernet network at the same time.

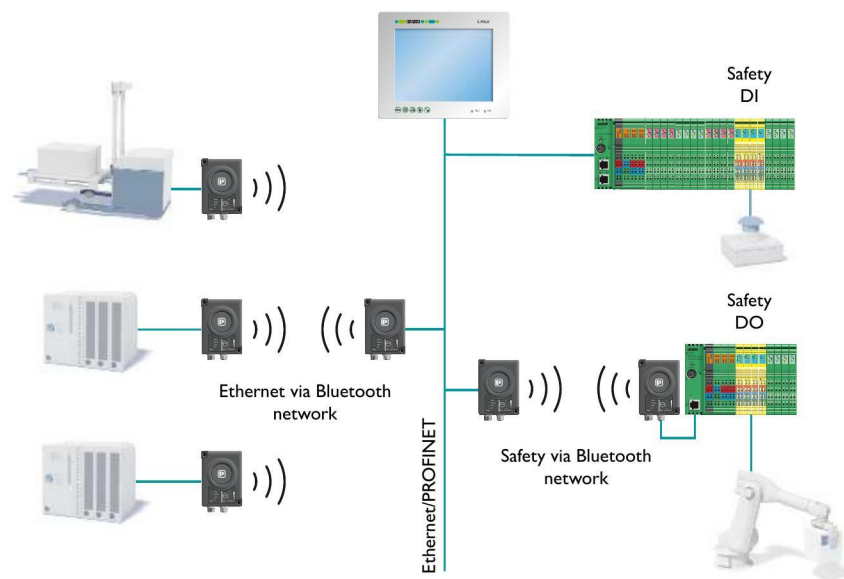

## Possible areas of application

Bluetooth enables mobile devices to be integrated into industrial control networks wirelessly, thereby eliminating the need for expensive cable runs that are prone to wear.

- Robots and traveling robots
- Handling machines, packaging machines, pallet wrapping machines
- Moving machine parts
- Cranes and lifting equipment



Industrial Bluetooth on cranes



## Wireless Ethernet

# Industrial WLAN

Use industrial WLAN components for wireless machine access with smart devices or as a robust communication with mobile machine parts. Industrial wireless systems also provide for more flexibility and efficiency for reliable communication between controller and autonomous transport systems, warehouse shuttles or carry systems.

The industrial WLAN components WLAN 5110 and WLAN 1100 support you with the implementation of high performance and modern MIMO technology.

### Your advantages

- ✓ Create industrial WLAN networks easily and reliably
- ✓ Particularly secure, thanks to the latest security standards and encryption
- ✓ Ideal for networks with a large number of devices
- ✓ Maximum mobility, with fast roaming functions
- ✓ Suitable for time-critical applications, such as PROFINET or safety



# Product overview Industrial WLAN



## WLAN 5110 access point

FL WLAN 5110 (EU) Order No. **1043193**  
 FL WLAN 5111 (USA, CAN) Order No. **1043201**  
 SD-FLASH 2 GB Order No. **2988162**

- IEEE 802.11 a/b/g/n, WLAN access point, client, repeater, frequency band 2.4 GHz and 5 GHz, MIMO technology 2x2:2, up to 300 Mbps, cluster management

## WLAN 1100 wireless module

IP54:  
 FL WLAN 1100 (EU) Order No. **2702534**  
 FL WLAN 1101 (USA, CAN) Order No. **2702538**

IP65/66/67/68, expanded temperature range:  
 FL WLAN 2100 (EU) Order No. **2702535**  
 FL WLAN 2101 (USA, CAN) Order No. **2702540**

- IEEE 802.11 a/b/g/n, WLAN access point and client, frequency band: 2.4 GHz and 5 GHz, 2 integrated antennas with MIMO technology, power supply: 9 ... 32 V DC

## Possible areas of application

Wireless LAN is particularly suitable for implementing a system-wide wireless infrastructure:

- Mobile maintenance
- Electric monorail systems
- Automated guided vehicle systems and forklift trucks
- Storage and retrieval machines and warehouse shuttles
- Video monitoring



Wireless LAN in high-bay warehouse systems

## Typical WLAN network structure

The powerful WLAN 5110 and the compact WLAN 1100 are the perfect complements for wireless communication in the machine environment.

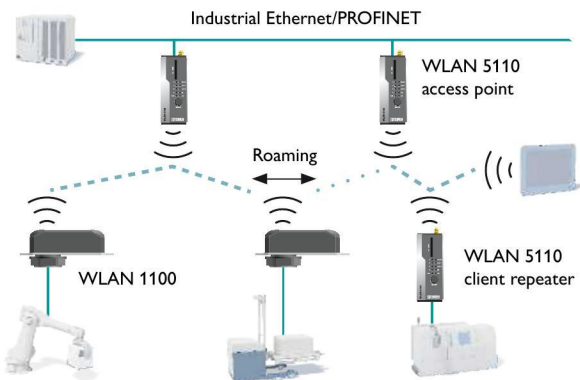

Wireless machine communication with industrial WLAN

## Connecting smart devices

The WLAN 1100 allows an easy connection of smart devices to machines and systems.

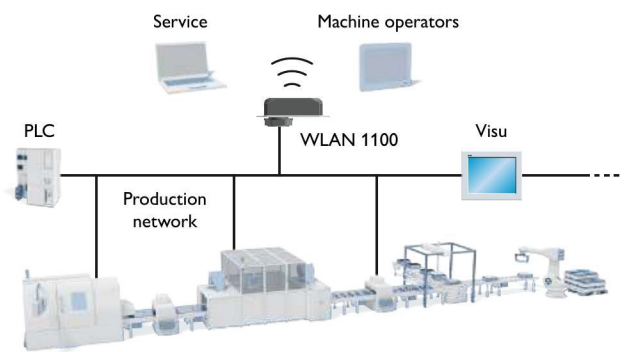

Wireless machine operation and service with wireless LAN

## Wireless Ethernet

# Mobile routers for worldwide network access

Mobile routers enable high-performance remote connections to industrial Ethernet networks. This makes it possible to transmit sensitive data securely over networks from machines and systems. The integrated firewall and VPN (Virtual Private Network) support protect against unauthorized access.

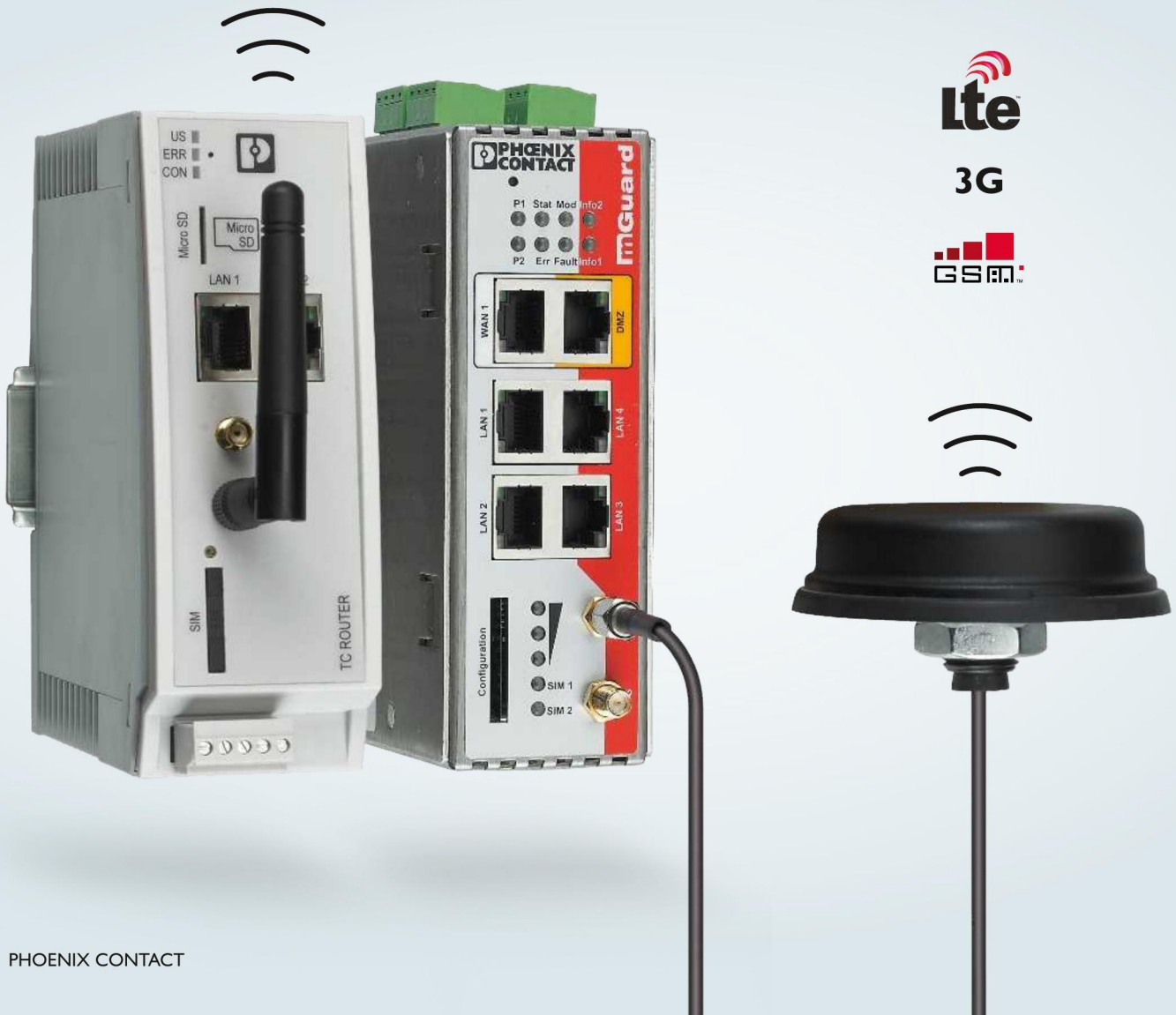



# Product overview 4G mobile routers



## 4G mobile routers (LTE)

### TC ROUTER...

... 3002T-4G	Order No. <a href="#">2702528</a>
... 2002T-4G	Order No. <a href="#">2792530</a>
... 3002T-4G VZW	Order No. <a href="#">2702532</a>
... 3002T-4G ATT	Order No. <a href="#">2702533</a>

- Worldwide high-speed data links and alarm generation via 4G mobile phone networks
- Fallback to UMTS/HSPA and GPRS/EDGE
- Support for IPsec and OpenVPN (TC Router 3002T)

## Industrial VPN gateways

### TC CLOUD CLIENT...

... 1002-4G	Order No. <a href="#">2702886</a>
... 1002-4G VZW	Order No. <a href="#">2702887</a>
... 1002-4G ATT	Order No. <a href="#">2702888</a>

- High security, thanks to a VPN tunnel to the mGuard Secure Cloud
- Pluggable configuration memory
- Can be used in Europe and North America
- Connection for key switch
- Cloud-based device configuration

## Security routers 4G (LTE)

### TC MGUARD...

... RS4000 4G VPN	Ord. No. <a href="#">2903586</a>
... RS2000 4G VPN	Ord. No. <a href="#">2903588</a>
... RS4000 4G VZW VPN	Ord. No. <a href="#">1010461</a>
... RS2000 4G VZW VPN	Ord. No. <a href="#">1010462</a>
... RS4000 4G ATT VPN	Ord. No. <a href="#">1010463</a>
... RS2000 4G ATT VPN	Ord. No. <a href="#">1010464</a>

- Easy configuration via central management tool
- Easy integration, thanks to integrated Ethernet switch
- Compatible with mGuard Secure Cloud

## Data links

- Worldwide Internet data link via mobile phone networks at up to 150 Mbps
- Flexible use in small machines to larger system networks
- Secure VPN communication
- Mobile routers also available as cost-effective 3G versions

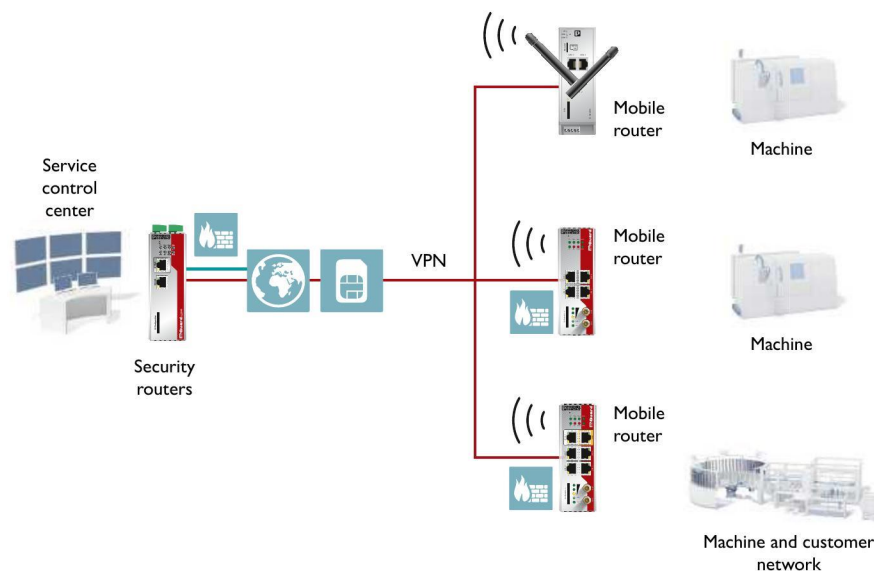

VPN communication via the mobile phone network

## Remote maintenance via the Cloud

The mGuard Secure Cloud securely connects service personnel and remote maintenance locations via the Internet in the framework of an encrypted VPN complete solution. Service personnel connect quickly and securely to machines, industrial PCs, and controllers via a simple web interface. In addition, secure remote maintenance can be performed at any location and any time without requiring specialist IT knowledge.



# Antenna installation – Basics and technology

## Indoor applications

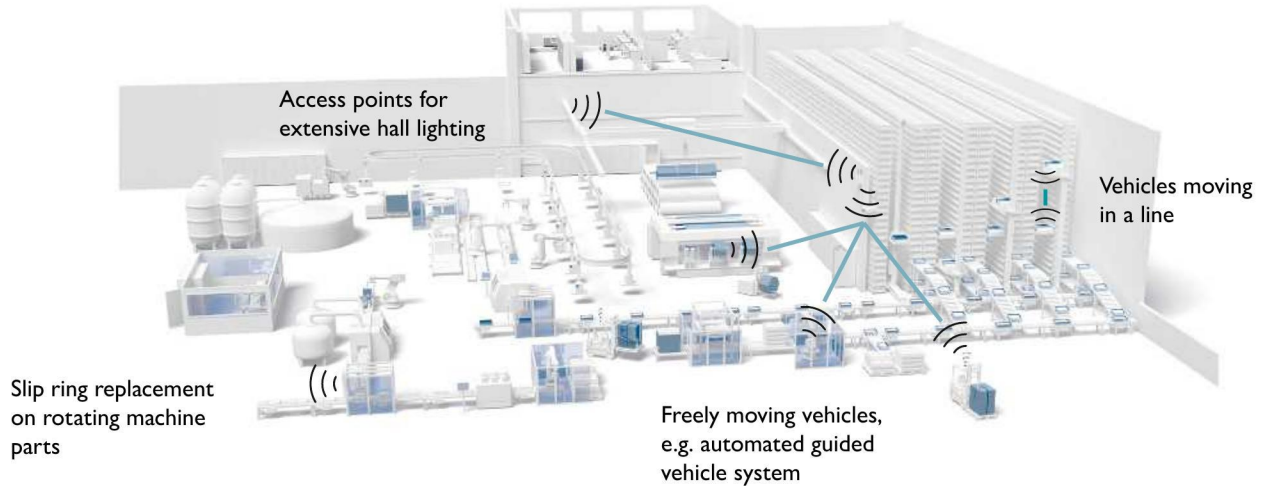

## Outdoor applications

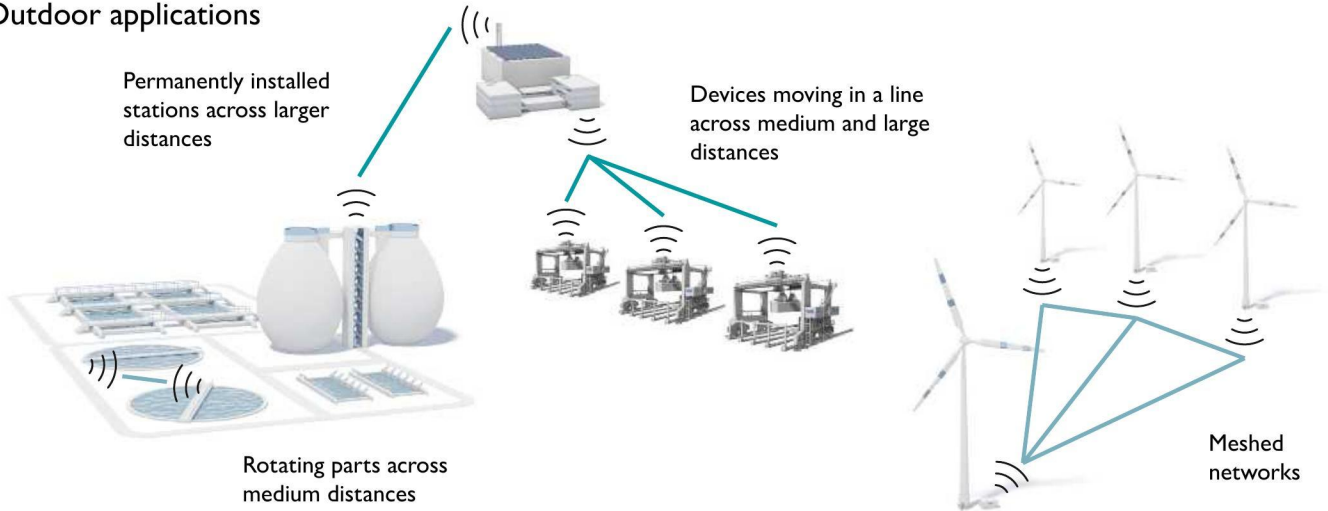

## Omnidirectional antenna

Omnidirectional antennas are used when the wireless modules are facing different directions or are mobile. As a result of their lower gain, they are more suitable for short to medium distances. In reflective indoor environments where there is no line of sight, the signal may be reflected from the sender to the receiver. In such cases, it is important to ensure that the omnidirectional antenna is not mounted immediately in front of reflective (metallic) surfaces.

The ideal installation location is the top of a mast or on a control cabinet so that the antenna has the greatest possible free space in all directions. In the case of multiple omnidirectional antennas, these should be installed with sufficient spacing.

## Directional antenna

The use of directional antennas is recommended at permanently installed, remote stations when large distances need to be covered with a line of sight. Directional antennas emit the transmission power in a specific direction. This increases the range and reduces the chances of interference from other users outside of the field of transmission.

The higher the gain of a directional antenna, the smaller its field of transmission (opening angle). This means that the antennas need to be precisely aligned with one another.

# Cables and adapters

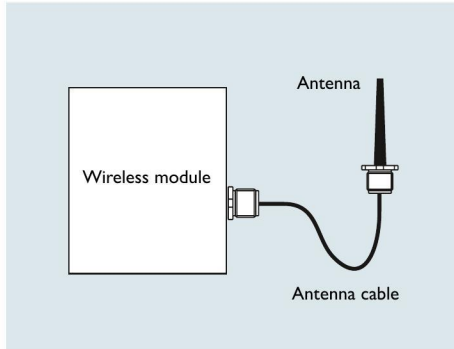

## Simplified antenna connection

All wireless modules with an RSMA connection are connected directly to the N connection of the antennas via a cable. Various cable lengths between 50 cm and 5 m are available.

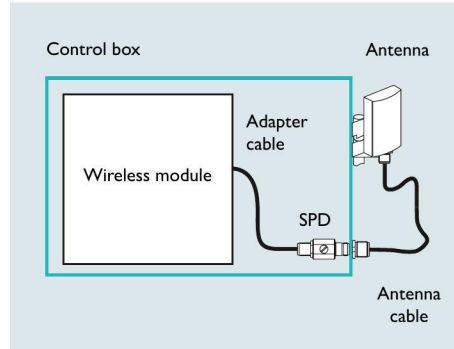

## Installation in an IP54 control box

A wireless module is connected with the SPD surge protection via an RSMA to N adapter cable. The SPD is used as the panel feed-through. The SPD is connected to the antenna with the N to N extension cable.

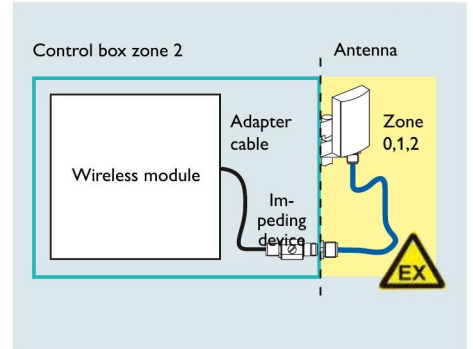

## Installation in the Ex area

The impeding device makes the HF outputs of the wireless modules intrinsically safe (Ex i). It limits the ignition energy in the event of an error.

## Planning a radio link

There should be a line of sight, especially in the event of longer distances, between the antennas of the wireless devices. To keep the Fresnel zone free from any obstacles, it may be necessary to mount the antennas a few meters high. This area should also be free from any other obstacles.

### Obstacles outside or inside buildings

The wireless path may also work if obstacles are within the Fresnel zone (house, tree, etc.). The decisive factor is the number of obstacles and the area they occupy in this zone. In this case, it is recommended that you perform test measurements.

Inside buildings, in conventional automation environments, there is a predominance of reflections, which do not occur outdoors. They contribute to a good wireless connection even if the Fresnel zone is not free from obstacles.

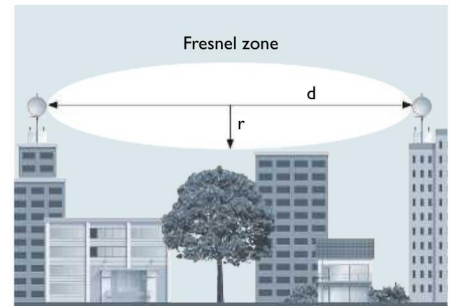

The radius of the Fresnel zone corresponds to the desired antenna height. It depends on the radio frequency and the distance between the antennas.









## Necessary antenna height depending on the distance

Wireless path distance (d)	Antenna height (r) 868/900 MHz	Antenna height (r) 2.4 GHz	Antenna height (r) 5 GHz
200 m	4 m	2.5 m	1.5 m
500 m	6.5 m	4 m	2.5 m
1,000 m	9 m	5.5 m	4 m
2,000 m	13 m	8 m	5.5 m
4,000 m	18.5 m	11 m	8 m
10,000 m	29 m	–	–
20,000 m	41.5 m	–	–
30,000 m	50 m (900 MHz only)	–	–

Note: Due to the laws of physics, the range and material penetration of obstacles for 868 MHz radio waves is twice as good as for 2.4 GHz. Radius of the Fresnel zone depending on the frequency and distance. This gives the mounting height for wireless devices (antennas).



## Product overview for antennas and accessories



Antennas					
<b>868 MHz</b>					
	Description	Gain	Connection	Features	Order No.
	Omnidirectional antenna	2 dBi	N (female)	Temperature range: -40°C ... +75°C, degree of protection: IP65, including mounting bracket	2904802
	Omnidirectional antenna, vandalism proof	2.5 dBi	N (female)		1090616
	Omnidirectional antenna, salt water resistant 	4 dBi	N (female)		2702136
	Directional antenna for panel, saltwater-resistant 	3.5 dBi	N (female)		2702137
	Yagi directional antenna	8.5 dBi	N (female) with 0.6 m cable		2867814
Yagi directional antenna	12 dBi	N (female) with 0.6 m cable	5606614		
<b>900 MHz</b>					
	Omnidirectional antenna	2 dBi	RSMA (male) with 1.5 m cable	Temperature range: -40°C ... +80°C, degree of protection: IP65, including mounting bracket	2904801
	Omnidirectional antenna	2 dBi	N (female)		2904802
	Omnidirectional antenna	5 dBi	N (female)		2867791
	Omnidirectional antenna	7 dBi	N (female)		2867199
	Yagi directional antenna	5 dBi	N (female) With 0.6 m cable		2867801
	Yagi directional antenna	8.5 dBi	N (female) With 0.6 m cable		2867814
	Yagi directional antenna	12 dBi	N (female) With 0.6 m cable		5606614
<b>2.4 GHz</b>					
	Omnidirectional antenna	2 dBi	RSMA (male) with 1.5 m cable	Temperature range: -40°C ... +70°C, degree of protection: at least IP65, including mounting bracket	2701362
	Omnidirectional antenna, vandalism proof	3 dBi	RSMA (male) with 1.5 m cable		2701358
	Bracket for wall mounting	-	For antennas with protection against vandalism		2885870
	Omnidirectional antenna, salt water resistant 	6 dBi	N (female)		2885919
<b>5 GHz</b>					
	Omnidirectional antenna	5 dBi	N (female)	Temperature range: -40°C ... +70°C, degree of protection: at least IP65, including mounting bracket	2701347
	Directional antenna, dual slant	9 dBi	N (female)		2701348
<b>2.4 GHz and 5 GHz</b>					
	Omnidirectional antenna	2.5 dBi at 2.4 GHz 5 dBi at 5 GHz	N (male)	Temperature range: -40°C ... +70°C, degree of protection: at least IP65, including mounting bracket	2701408
	Omnidirectional antenna, vandalism proof	Up to 6 dBi at 2.4 GHz Up to 8 dBi at 5.6 GHz	N (female)		2702898
	Directional antenna for panel, saltwater-resistant 	9 dBi	N (female)		2701186

## Antenna cable

### N (male) > N (male)

	Description	Frequency	Order No.
	0.5 m	0.3 ... 6 GHz	2700677
	3 m	0.3 ... 6 GHz	2867649
	5 m	0.3 ... 6 GHz	2867652
	10 m	0.3 ... 6 GHz	2867665
	15 m	0.3 ... 6 GHz	2885634
	6 m	900 MHz	5606125
	15 m	900 MHz	2867225
	30 m	900 MHz	2867238

### RSMA (male) > N (male)

	0.5 m	0.3 ... 6 GHz for the control cabinet feed-through	2701402
	0.5 m	0.3 ... 6 GHz	2903263
	1 m	0.3 ... 6 GHz	2903264
	2 m	0.3 ... 6 GHz	2903265
	3 m	0.3 ... 6 GHz	2903266
	5 m	0.3 ... 6 GHz	2702140

## Accessories

### Adapters and antenna splitters

	Description	Frequency	Connection	Features	Order No.
	Adapters	0.3 ... 6 GHz	N (female) > N (female)	For the control cabinet feed-through	2867843
	Adapter, 90° angled	0.3 ... 6 GHz	RSMA (male) > RSMA (female)	For control cabinets with little room	2904790
	Antenna splitter	0.3 ... 6 GHz	3 x N (female)	2-way splitter	2702293

### Surge protection

	Surge protection	868 MHz, 900 MHz	N (female) > N (female)	For the control cabinet feed-through	2803166
	Surge protection, with Lambda/4 technology	2.4 GHz 5 GHz			2838490

## Product overview for antennas and accessories

Accessories					
<b>Leaky wave cable (LCX)</b>					
	Description	Features			Order No.
	Leaky wave cable 2.4 GHz	Longitudinal loss: 14.7 dB/100 m, coupling attenuation 95%: 60 dB, temperature range: -40°C ... +85°C			2702553
	Leaky wave cable 5 GHz	Longitudinal loss: 19.1 dB/100 m, coupling attenuation 95%: 71 dB, temperature range: -40°C ... +85°C			2702860
	Assembly tool	Planing tool for precise mounting of the connectors on the leaky wave cable			2702519
	Connector	Connector for leaky wave cables N (female)			2702518
	Cable tie	Mounting clamp for securing the leaky wave cable			2702520
	Termination resistor	N (male) required for capping the open leaky wave cable end			2884978
Termination resistor	RSMA (male) for capping the open antenna port of the WLAN APs			2702702	
<b>Antenna impeding device for the Ex area</b>					
	Description	Connection	Features		Order No.
	N connector, double-sided, 0.7 ... 6 GHz	 N (female) > N (female)	Installation in the Ex zone 2, installation of standard antennas in zones 0, 1, 2		2702198
<b>Mobile communication accessories</b>					
<b>Omnidirectional antennas</b>					
	Description	Technology	Connection	Features	Order No.
	Omnidirectional antenna	GSM/UMTS	2 m antenna cable with SMA round plug	For mounting on the control cabinet	2313371
	Combined omnidirectional antenna with GPS	GSM/UMTS/GPS	2 m antenna cable, SMA for mobile communication, RSMA for GPS	For mounting on the control cabinet	2903590
	Omnidirectional antenna	GSM/UMTS/LTE	5 m antenna cable with SMA circular connector	For wall or mast mounting	2702273
Omnidirectional antenna	GSM/UMTS	SMA circular connector (without antenna cable)	For mounting directly on the device	2313342	
<b>Antenna cable</b>					
	Description	Attenuation	Connection	Features	Order No.
	5 m	0.23 ... 0.44 dB/m	SMA (male) > SMA (female)	Impedance: 50 Ohm	2900980
10 m	2900981				



## Mobile communication accessories

### Angle adapter

	Description	Connection	Features	Order No.
	90° adapter	SMA (female) > SMA (male)	For connecting the GSM/UMTS antenna cable where space is restricted	2917324

### Surge protection set

	Description	Connection	Features	Order No.
	Attachment plug	SMA connector/socket	With Lambda/4 technology as surge protection for coaxial signal interfaces	2800491

### Sealing tape

	Description	Features	Order No.
	3 m	Self-vulcanizing, for external protection of adapters, splitters or cable connections, watertight	2903182

## Control box sets

### For outdoor mounting

	Description	Features	Property	Order No.
	Set for constructing wireless systems	For industrial applications, IP65, with DIN rail, plugs, and screw connections, without devices	With omnidirectional antennas	1088098
			With omnidir. antennas and power supply unit	1088095
			With omnidirectional antennas and PoE splitter	1088097
			Without antenna accessories	2701204

## Radioline accessories

### Configuration memory, memory stick, and USB cable

	Description	Connection	Frequency	Features	Order No.
	Configuration memory RF band 3	S-PORT	2.4 GHz	For easy and secure network addressing with unique network ID	2902814
	Configuration memory RF band 5	S-PORT	2.4 GHz		2902815
	Configuration memory RF band 7	S-PORT	2.4 GHz		2902816
	Configuration memory RF band 1	S-PORT	868 MHz		2702197
	Configuration memory RF band 1	S-PORT	900 MHz		2702122
	Memory stick	S-PORT	For all Radioline front modules	Freely configurable	2902828
	USB cable	USB / S-PORT	For all Radioline front modules	For diagnostics and configuration	2903447

# You can count on us

You do not need to be an expert. We provide you with much more than products. We also provide you with support whenever you need it.

Phoenix Contact offers on-demand professional support, from consultation, through network analysis and design, right through to configuration support and startup. We not only support you over the phone or by e-mail, but also directly on site, if you so desire. Contact us for more information.

## For professional wireless coverage

Give us the coordinates of the stations to be networked, and we will check the feasibility using our wireless network planning software or by performing wireless path tests on site. You will receive an extensive test report and a bill of material including all required components.

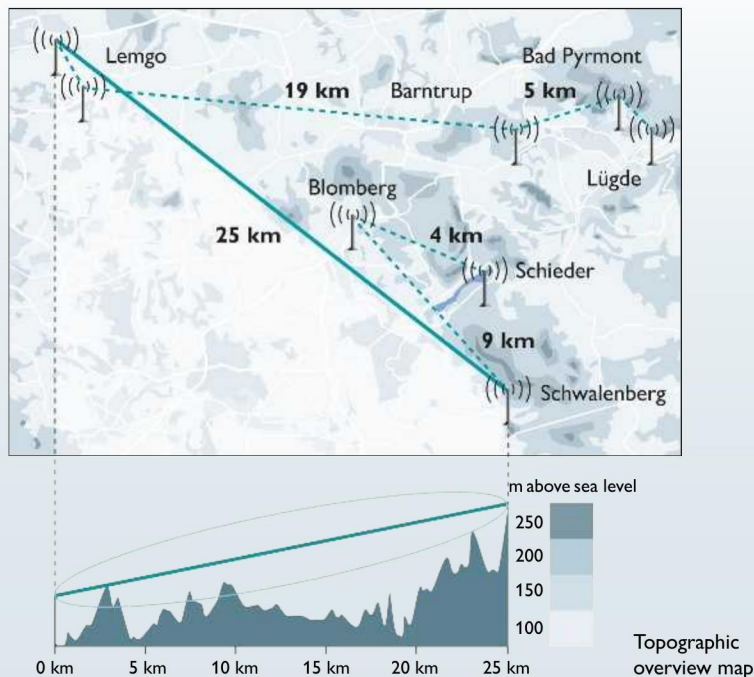

## Planning and consultation

Whether for failsafe network structures, protecting or remotely maintaining your machinery, or high-performance wireless networks, we will find the right solution for you.





### Configuration and startup

We provide support during the configuration and startup of your network and show how to optimize the performance, availability and safety.



### Maintenance and support

If your network is not working in accordance with your expectations, we will eliminate any faults. We will analyze your network and assist you and provide recommendations.



### Training and workshops

Do you want to gain a better insight into network engineering for yourself or your staff? We provide perfectly tailored instruction and practical training.



## In dialog with customers and partners worldwide

Phoenix Contact is a globally present, Germany-based market leader. Our group is synonym for future-oriented components, systems, and solutions in the fields of electrical engineering, electronics, and automation. A global network across more than 100 countries, and 16,500 employees ensure a close proximity to our customers, which we believe is particularly important.

The wide variety of our innovative products makes it easy for our customers to find future-oriented solutions for different applications and industries. We especially focus on the fields of energy, infrastructure, process and factory automation.



You will find our complete product range at:  
[phoenixcontact.com](http://phoenixcontact.com)

PHOENIX CONTACT GmbH & Co. KG  
Flachmarktstraße 8  
32825 Blomberg, Germany  
Phone: +49 52 35 3-00  
Fax: +49 52 35 3-4 12 00  
E-mail: [info@phoenixcontact.com](mailto:info@phoenixcontact.com)  
[phoenixcontact.com](http://phoenixcontact.com)

  
INSPIRING INNOVATIONS

RSPSupply - 1-888-532-2706 - <https://www.RSPSupply.com>  
See the product details here